

# RESEARCH AND DEVELOPMENT BEAMLINE FOR THE BESSY II BOOSTER

P. Ahmels\*, T. Atkinson, M. Marongiu, G. Rehm, M. Ries  
Helmholtz-Zentrum Berlin für Materialien und Energie (HZB), Berlin, Germany

## Abstract

With the refurbishment completed, the optical beamline delivers all the required diagnostics. This paper reports on their status focusing in particular on the R&D beamline branch. The additional branch is equipped with programmable mirror and lens position controllers allowing elaborate optical optimisation. This system is used for educational purposes and for improving the source point imaging system through the study of polarisation characteristics. Test systems for an ultra-fast diode and a THz detector are equipped with CMOS cameras and polarisation filters. Furthermore the R&D branch complements the existing diagnostics to measure bunch lengths and investigate non-linear beam dynamics.

## MOTIVATION

After the optimisation process of the high-end diagnostic, the main focus was on expanding the beamline further. The first addition to the R&D branch was an ultra-fast diode in combination with a CMOS camera for measuring longitudinal beam properties and photon counting. Through later including a polarisation filter, new insights regarding the non-zero divergence of the photon beam, contributed to optimise the diagnostic tool to a greater degree (Fig. 1). Furthermore, a THz detector was installed into the telescope optic to measure non-linear beam dynamics on injection [1].

Extending the beamline is essential to optimise and to increase the measurement capabilities of the diagnostic tool, to ensure tailored beams for high injection efficiency into the BESSY II storage ring.

## BOOSTER BEAMLINE

The beamline consists of a motorized achromatic telescope, of 400 mm and 80 mm focal length lenses, and seven planar mirrors to transport the photons from the bending magnet to the optical table. For precise angle adjustment and fine tilt, three Mirrors are motorized. To compensate the angular dispersion entering the beamline, wedged vacuum windows are installed. On the optical table, the beamline is divided in three branches: the two main diagnostic tools on the optical table are a CCD camera with a 500 mm focusing achromatic doublet for source point analysis and a streak camera with a 300 mm focusing achromatic doublet for bunch length studies [2]. Using a mirror mounted on a linear stage, the beam is transported to one of the two branches.

\* pauline.ahmels@helmholtz-berlin.de

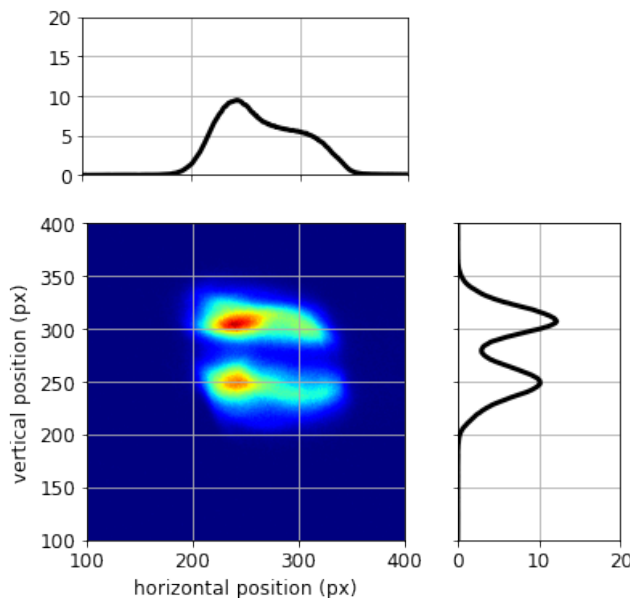

Figure 1: Image captured by CMOS camera showing circular polarisation outside of the focal point at high Booster energies with dominating vertical beam profile.

To expand the measurement possibilities, an R&D beamline is accessible via a 50/50 splitter on the optical table. The R&D beamline uses a programmable motorized mirror and 500 mm achromatic doublet to focus on one of the three different main setups shown in Fig. 2:

- a CMOS camera from Basler [3] with a rotatable polarizer
- an ultra-fast diode from Hamamatsu [4] connected to a 12 GHz oscilloscope and digital multimeter
- an ultra-fast diode connected to a digital multimeter combined with a CMOS camera via a 30/70 splitter

Measurements for photon intensity, polarisation modes and bunch length are possible with these setups. Furthermore, a THz detector [5] is installed in between the telescope.

## OPTIMISING PHOTON INTENSITY USING FEEDBACK

To effectively use the R&D branch the system is continually optimized. Two different approaches are used, both with the goal of maximizing the photon count on the diode. The first is a combination of the diode linked with a CMOS camera through a feedback code. The feedback code moves the motors of the mirror, changing the angle, and analyzes

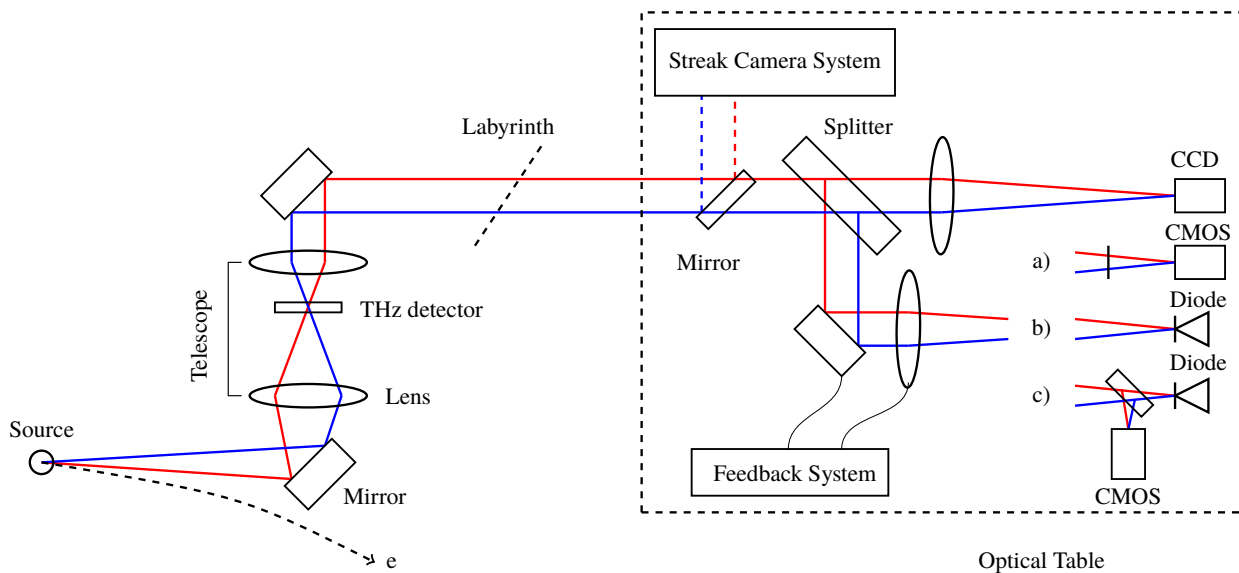

Figure 2: Schematic of the booster beamline and the present experimental setup on the optical table in the R&D branch.

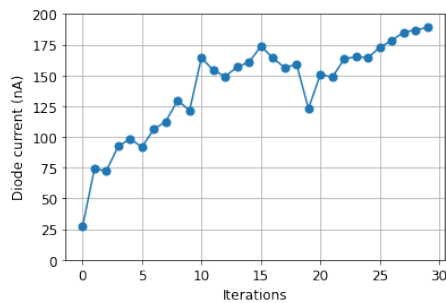

Figure 3: Biased random walk changing beam position to find maximal photon intensity measured through diode current at single bunch.

the following movement on the camera. Using a grid, the highest intensity on the diode can be determined in relation to a pixel position on the CMOS camera. For the next step, the lens can be moved parallel to the beamline. Any inaccuracies in the beamline can be compensated through the feedback code. The feedback code tracks varying beam positions on the camera and searches the optimal point, securing a maximal photon count. Due to its robustness, this feedback approach is used for optimizing the telescope in the system. The optimal solution is then confirmed on the source point imaging branch of the beamline. As expected there has been no significant differences when using a CCD or CMOS based camera.

## BUNCH LENGTH STUDIES WITH ULTRA-FAST DIODE

The second approach works without using a CMOS camera for orientation and is less target-oriented. The beam lands directly on the diode and, using a biased random walk optimizer coded in python, the highest signal can be found and measured on a multimeter.

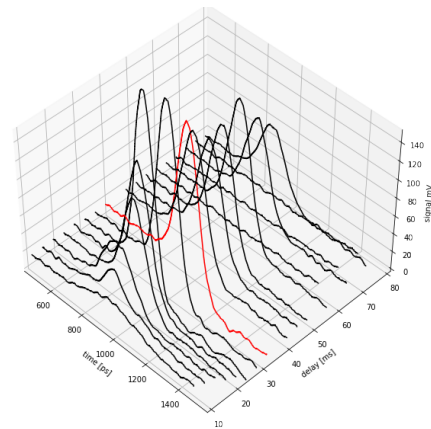

Figure 4: Bunch length measurements using a diode. The red curve represents the working point at delay 30 ms ( $\approx 1.7$  GeV) with  $\sigma = 71$  ps. This is in good agreement with the value measured by the streak camera [2].

Although the random walk script has evolved and is now many lines of code long, the essence is the attribute from the `np.random.choice()` function that acts on an array that is slightly biased towards higher diode currents already measured in the actual for-loop. A magnitude increase in diode current after 30 iterations at 1 Hz as shown in Fig. 3 was achieved. The approach is less stable over long periods, but is quick to set up and delivers a high photon intensity needed for a bunch length measurement. The final goal was to confirm the streak camera measurements and observe the elusive first turn in the booster at 50 MeV. The longitudinal profiles at the different energies are measured with an oscilloscope (Fig. 4). The rise time of the diode limits the resolution of bunch length measurement. The streak camera confirms at 1 GeV the rms bunch length is approximately 50 ps [2].

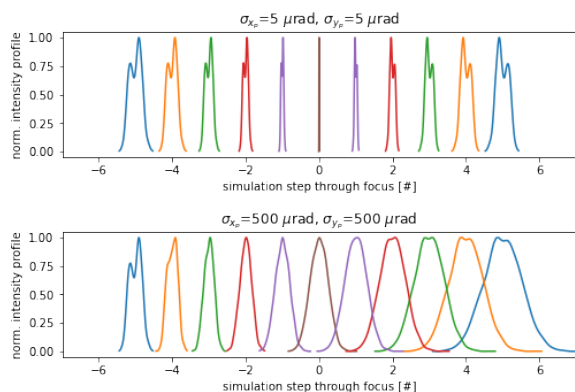

Figure 5: Vertical beam profile of circular polarisation at different positions offset to the focal plane at step zero.

## CHARACTERISING POLARISATION

For this setup, a CMOS camera is installed with a freely rotatable polarisation filter. The goal is to characterize both polarisation modes observed during the Booster cycle. To eliminate errors, the system, which is controlled and determined through the coded movements of the mirror motors, can be near perfectly aligned. The working point of the source point imaging system is independent of the polarisation.

As expected, circular polarisation dominates the vertical beam profile outside of the focal point at high Booster energies. Visible in Fig. 1 are two distinct beam lobes observed at a camera position before the focal point. If one assumes perfect linear optic, the beam lobes should show symmetrical behaviour either side of the focal plane. Experimentally, this was not observed. The beam image differs significantly either side of the focal plane. The results show a smearing effect, where the vertical profile does not show two clear maxima on one side of the focus. The smearing could be slightly reduced through programmable optic alignment optimisation.

In order to understand this smearing effect, a simulation study using real measured data was undertaken. A particle distribution was created using the pixel intensity profiles from the camera image shown in Fig. 1 for the horizontal and vertical positions, coupled with a Gaussian spread in divergence. These particle distributions were then tracked through a simple drift-lens-drift optic and could be readily analysed through the focal point to depict the smearing behaviour.

Changing the Gaussian divergence of the initial beam distribution shows that the smearing effect dominates at values greater than  $5 \mu\text{rad}$  (Fig. 5). Realistically, the mechanical precision of the lens position is limited to circa  $0.1 \text{ mm}$  therefore limiting the divergence to circa  $50 \mu\text{rad}$ . To achieve a higher resolution and reduce the divergence of the beam, more precise motors in the achromatic telescope system are required.

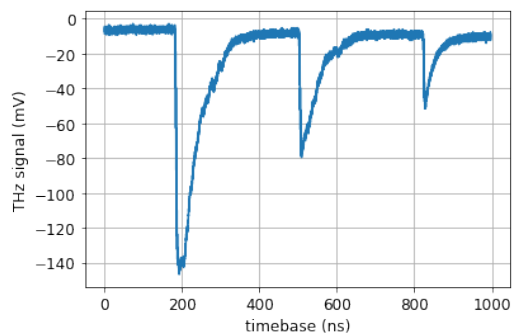

Figure 6: Raw THz signal over the first few turns in the booster, revolution time 320 ns.

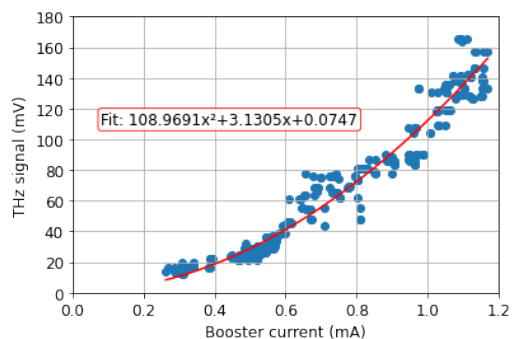

Figure 7: The quadratic dependence of the THz signal as a function of booster current.

## THz STUDIES

In order to compliment the streak camera longitudinal dynamic studies, a high-sensitivity wideband THz detector was installed in the tunnel section of the beamline. This quasi-optical A1M Device from ACST [5] is attached to a retractable stage within the telescope system shown in Fig. 2. Covering the low THz regime, this Schottky-barrier diode detector was used to measure coherent radiation produced in the first turn in the Booster.

The amplitude of the signal detected from the first turn is of course strongly dependent on the longitudinal profile of the bunch leaving the linac. The phase of the 500 MHz pre-buncher [6] was used to optimise the signal intensity shown in Fig. 6. The fast signal rise time due to the diode and the slow decay due to the internal amplifier is repeated for each turn. With  $1.2 \text{ mA}$  Booster current (circa  $0.4 \text{ nC}$  single bunch charge) the detector is already saturated. The coherent quadratic nature  $N^2$  of the radiation was measured and is shown in Fig. 7.

Future studies will be orientated towards predicting the longitudinal beam profile from the linac that could produce such a THz signal and assessing the possibility of tailoring the injection to produce multi-turn coherent synchrotron radiation CSR.

## OUTLOOK

Because of its flexibility, the R&D beamline is a great tool for educating students and continually improving the high level diagnostic at BESSY II.

Within the first year of research, it has been possible to study the bunch length, polarisation and THz footprints over the energy ramp of the Booster. These online diagnostics coupled with electron beam orbit improvements help to continually optimise the booster operation. High-current stable injection in BESSY II is now possible. Further studies are envisaged as part of a future MSc project.

## REFERENCES

- [1] T. Atkinson, J.-G. Hwang, G. Rehm, M. Ries, G. Schiwietz, and S. Wiese, “An Optical Diagnostic Beamline for the Bessy II Booster”, in *Proc. IBIC'22*, Kraków, Poland, pp. 19–22, 2022. doi: 10.18429/JACoW-IBIC2022-MOP02
- [2] M. Marongiu *et al.*, “Transverse and longitudinal optical beam diagnostics for the BESSY II Booster”, presented at IBIC'24, Beijing, China, Sep. 2024, paper THP55, this conference.
- [3] Basler the power of sight. “Aca1920-40gm - basler ace”. 06.08.2023, <https://www.baslerweb.com/de/produkte/kameras/flaechenkameras/ace/aca1920-40gm/>
- [4] Hamamatsu. “Ultrafast MSN Photodetectors G4176 Series (GaAs)”. discontinued refer to <https://www.hamamatsu.com>.
- [5] ACST. “Quasi-Optical THz Detector”, <https://www.acst.de>
- [6] T. Atkinson *et al.*, “Commissioning of the 50 MeV Preinjector Linac for the BESSY II Facility”, in *Proc. IPAC'11*, San Sebastian, Spain, pp. 3140–3142, 2011. <https://jacow.org/IPAC2011/papers/THPC108.pdf>.